

Design, calibration, and performance of MICROTOPS II handheld ozone monitor and Sun photometer

Marian Morys¹

Solar Light Co., Inc., Philadelphia, Pennsylvania

Forrest M. Mims III and Scott Hagerup

Geronimo Creek Observatory, Seguin, Texas

Stanley E. Anderson, Aaron Baker, Jesse Kia, and Travis Walkup

Westmont College, Santa Barbara, California

Abstract. MICROTOPS II is a five-channel, handheld Sun photometer that can be configured to measure total ozone, total water vapor, or aerosol optical thickness at various wavelengths. The instrument measures $10 \times 20 \times 4.3$ cm and weighs 600 g. A principal design goal was the measurement of total ozone to within 1% of ozone measurements made by much larger, heavier, and more expensive Dobson and Brewer spectrophotometers. This goal has been met for a maximum air mass of up to ~ 2.5 , as demonstrated by comparisons of MICROTOPS II and its immediate predecessor, Supertops, with Dobson and Brewer instruments at various locations. Conventional interference filters are subject to gradual and unpredictable degradation. MICROTOPS II avoids these problems by using highly stable ultraviolet filters manufactured with an ion deposition process. The 2.4 nm (FWHM) band pass of the UV filters was selected to balance noise and ozone measurement performance. The optical collimators and electronics of the instrument were carefully designed to optimize pointing accuracy, stray light rejection, thermal and long-term stability, signal-to-noise ratio, and data analysis. An internal microcomputer automatically calculates the total ozone column based on measurements at three UV wavelengths, the site's geographic coordinates, and universal time, altitude, and pressure. The coordinates can be entered manually or by a Global Positioning System (GPS) receiver. A built-in pressure transducer automatically measures pressure. MICROTOPS II saves in nonvolatile memory up to 800 scans of the raw and calculated data. Measurements can be read from a liquid crystal display or transferred to an external computer.

1. Introduction

Aerosols and ozone within the atmosphere modulate the intensity of ultraviolet radiation at the surface of the Earth. Since ozone absorbs shorter wavelengths more effectively than longer wavelengths, the ratio of the intensity of direct sunlight at two wavelengths within the range of 300–320 nm is related to the total abundance of ozone in a column through the atmosphere. This forms the basic operating principle for a variety of instruments that measure the ozone layer. The best-known ground-based ozone-monitoring instruments are the Dobson and Brewer spectrophotometers. Both these instruments divide sunlight into its constituent wavelengths by means of a spectrometer. The dispersing element is a quartz prism in the Dobson and a diffraction grating in the Brewer.

While the Dobson and the Brewer are universally accepted instruments for measuring column ozone, these instruments are expensive, heavy, and large. There has long been a need for

a compact instrument to measure column ozone with an accuracy that approaches that of the Dobson and Brewer. This paper describes an advanced filter ozonometer, MICROTOPS II, which provides this capability.

2. Filter Ozonometers

Many attempts have been made to use optical filters in ozone measuring instruments. Optical filters of the glass absorption type are used in the Russian M-83 spectrometer [Gushchin, 1963; Khrgian, 1973]. This instrument has been compared with a Dobson spectrometer by Bojkov [1969], who found differences between the measured ozone values of the two instruments of up to 30%. Oshervich *et al.* [1969] found even greater discrepancies in his analysis. The discrepancies have been attributed to the fairly wide filter bandwidth of ~ 25 –30 nm, which significantly affects the applicability of the Beer-Lambert law used to compute the ozone amount. Corrections based on the accurate ozone spectrum cannot easily be applied because of atmospheric aerosol scattering effects. Other drawbacks of the M-83 include its wide field of view and analog meter readout. While the M-83 has been supplanted by the newer and better-designed M-124, the filter band pass, field of view, and analog output limitations remain.

¹Now at Numar, a division of Halliburton, Malvern, Pennsylvania.

Ozonometers based on narrow-band-pass interference filters were first developed nearly 30 years ago, the first instrument having been described by *Boleshakova et al.* [1961]. *Osherovich et al.* [1969] and *Steblova* [1975] subsequently reported on its use. *Matthews* [1971], *Matthews et al.* [1974], and *Basher* [1975] developed an ozonometer for New Zealand's national atmospheric monitoring laboratory that used narrow-band-pass interference filters. The peak wavelengths of the filters were closely matched to the wavelengths used by the Dobson spectrometer.

3. Limitations of Filter Ozonometers

The key limitations of ozonometers that use narrow-band-pass interference filters have been reviewed in detail by *Basher and Matthews* [1977] and *Basher* [1977]. The most important difficulties with early interference filter instruments were relatively wide bandwidth, temperature dependencies, out-of-band radiation leakage, and aging of the filters, which produces a gradual increase in attenuation and a shift of the center wavelength.

Filter degradation can be caused by excessive exposure to direct sunlight, which is known as solarization, and possibly by changes in dimensionality due to reaction with absorbed moisture. Solarization can be reduced by placing one or more blocking filters before the interference filter. There is also the problem of manufacturing the filters to closely repeatable tolerances, which is related to the difficulty of accurately depositing the many thin layers that comprise an interference filter. Many of these early problems in fabricating interference filters have been overcome by advances in technology, and filters having a bandwidth of 1 nm or less are now available. Filters having metal oxide layers are much more resistant to aging and solarization. While filters cannot currently be made with absolutely identical performance specifications, they can be manufactured with a tolerance of 1–2%.

4. Total Ozone Portable Spectrometer (TOPS)

F. M. Mims applied the work of R. E. Basher and W. A. Matthews and high-quality interference filters to the development of a miniature, handheld filter ozonometer known as Total Ozone Portable Spectrometer (TOPS) [Mims, 1992a]. TOPS detects direct sunlight at 300 and 305 nm with filters having a full-width, half-maximum (FWHM) band pass of 5 nm. Two TOPS instruments were calibrated against the Total Ozone Mapping Spectrometer (TOMS) aboard NASA's Nimbus 7 satellite in the fall of 1990. This empirical calibration method provides a simple yet sensitive method for tracking slight differences in ozone measured from satellite and ground-based instruments [Mims, 1993]. The original two TOPS instruments have provided an 11 year, ongoing time series of total ozone over south Texas at local solar noon. They have also measured fluctuations in the ozone layer during the total solar eclipse of 1991 [Mims and Mims, 1993] and the reduced ozone following the eruption of Mount Pinatubo in 1991 [Mims et al., 1995a].

The success of TOPS resulted in a 1993 Rolex Award [Reed, 1993] that funded the development of Microtops, a microprocessor-controlled version of TOPS with five channels: 297, 303, 310, 940, and 1020 nm. The three UV channels measure total column ozone and direct UVB. The ratio of the 940 nm and

1020 nm channels permits the measurement of total column water vapor. S. Hagerup designed the electronic circuitry in Microtops, and Advanced Concept Electronics fabricated 32 instruments.

Several Microtops instruments were calibrated using the Langley method at Mauna Loa Observatory (MLO), Hawaii, in June 1995. Results of the Langley calibrations and ozone amounts measured by the MLO Dobson (instrument 76) were incorporated into the algorithm discussed in detail below to provide calibration algorithms for each instrument. *Labow et al.* [1996] and *Flynn et al.* [1996] of NASA's Goddard Space Flight Center compared a Microtops previously calibrated at MLO with a Brewer spectrophotometer. This independent comparison established that ozone retrievals from the Microtops were typically within 2% of those by the Brewer.

Supertops, a Microtops with narrow-band filters (FWHM = 2.2 nm) at 297, 300, 303, 310, and 312 nm, was the first instrument to detect record low ozone over the southern United States during the fall of 1994 [Mims et al., 1995b]. Supertops was compared with a Brewer spectrophotometer (instrument 112) placed at Geronimo Creek Observatory in South Texas (29.6°N, 97.9°W) by the University of Georgia and the U.S. Environmental Protection Agency during the summer of 1995. As the results of this comparison led to the decision by the Solar Light Company to manufacture MICROTOPS II, it is appropriate to briefly summarize them here.

Simultaneous measurements of total ozone were made with Brewer 112 and Supertops at or near solar noon on 52 days. The mean ozone measured during this comparison by the Brewer and Supertops was 291.3 (standard deviation of 6.5) Dobson units (DU) and 293.5 (standard deviation of 6.6) DU, respectively. Thus the mean difference in total ozone measured by the two instruments was 2.2 DU, or 0.9%. While there was excellent agreement on most days, scatter in the measurements limited the correlation ($r^2 = 0.47$).

On August 5, 1995, 18 simultaneous observations of total ozone by Brewer 112 and Supertops were conducted from morning (0815 local standard time (LST); air mass $m = 2.04$) to afternoon (1642 LST; $m = 1.82$). Cumulus clouds were present, the column water vapor was moderately high (3.9 cm), there was typical summer haze (aerosol optical thickness (AOT) at 500 nm equals 0.35), and the ratio of diffuse to full-sky UVB at 308 nm was higher than usual (0.64). The total ozone measured at local solar noon by the TIROS Operational Vertical Sounder (TOVS) was 282 DU. (A working Total Ozone Mapping Spectrometer (TOMS) was not in orbit.) The mean ozone measured by the Brewer and Supertops during this 8.5 hour comparison was 289.8 (standard deviation of 3.1) DU and 289.3 (standard deviation of 2.7) DU, respectively. Thus the mean difference in total ozone measured by the two instruments was 0.5 DU, or only 0.16%. This very close agreement is especially significant in view of the independent calibration of the two instruments prior to the comparison.

An important operational advantage of Supertops quickly became apparent during the comparison. The Brewer measures ozone at preprogrammed intervals by scanning a range of UV wavelengths. Thus clouds or cloud fragments that pass before the Sun during a scan can adversely influence the ozone measurement. Since Supertops measures ozone in the time it takes to press a button, it can make observations during even brief openings between passing clouds.

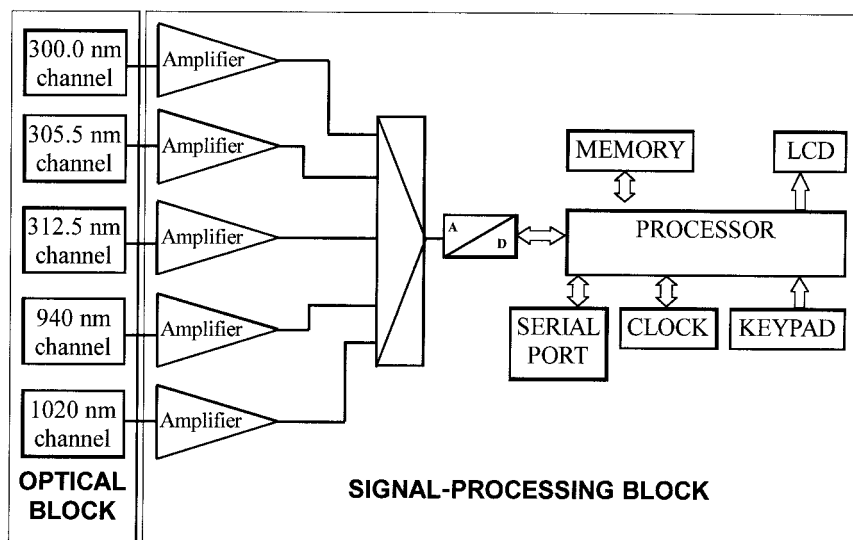

Figure 1. MICROTOPS II operational block diagram.

5. MICROTOPS II Design

The success of Microtops and Supertops led to the decision to use similar filter wavelengths in MICROTOPS II, the significantly advanced version of Microtops designed by M. Morys while he was at the Solar Light Company, which is the subject of the remainder of this paper (more information about MICROTOPS II is available from the Solar Light Company at <http://www.solar.com/mtops.htm>). Original versions of MICROTOPS II have five channels at 300, 305, 312, 940, and 1020 nm. Because the signal at 300 nm is quite weak, especially during winter and at high latitudes, the 300 nm channel has been deleted. The UV wavelengths of current versions of MICROTOPS II are 305.5, 312.5, and 320.0 nm.

The filters used for the three UV channels have a FWHM band pass of 2.4 nm, and the precision of the peak wavelength is ± 0.3 nm. The filters are fabricated using an ion deposition process that enhances their stability over time. The near-IR filters have a FWHM band pass of 10 nm and a precision of ± 1.5 nm.

MICROTOPS II measures $10 \times 20 \times 4.3$ cm and weighs 600 g. Four AA 1.5 V cells provide power. A quartz window provides access to the collimator tubes for the five photodiodes and a Sun alignment target. A spring-loaded door protects the window when the instrument is not in use. In operation the window door is left closed while power is applied to the instrument. The instrument adjusts the offset of each channel to zero while the photodiodes view the inner black surface of the window door. Unless they have been previously entered, the date, universal time, and geographic coordinates must next be entered manually into the instrument's keypad or automatically by a Global Positioning System (GPS) receiver.

The operator then opens the window door and points the instrument toward the Sun until a bright point of light is centered over a cross hair in a Sun target window. A scan button is then pressed to initiate a programmable number of rapid scans of each of the five channels. A self-contained microcomputer automatically calculates the total column amounts of ozone and water vapor, the aerosol optical thickness (AOT) at 1020 nm, and the irradiance at each wavelength. These and

other data can be viewed on a digital readout or sent to an external computer.

MICROTOPS II stores in nonvolatile memory up to 800 scans of the raw and calculated data. Each scan includes the time and date, the temperature inside the instrument, the barometric pressure, and the geographic coordinates. While this paper describes the ozone and column water vapor version of the instrument, an alternative version is configured as a Sun photometer that measures up to five wavelengths of sunlight and automatically computes the aerosol optical thickness (AOT).

The overall design of MICROTOPS II is shown in Figure 1. The optical block determines the field of view of the instrument, filters the incoming radiation, and detects and facilitates targeting at the Sun. The electrical signals from the five photodetectors are amplified, converted to a digital form, and numerically processed in the signal-processing block.

5.1. Optical Block

The success of the instrument depends on its ability to measure the ozone column with long-term stability under a broad range of air masses and atmospheric conditions. The performance for the entire instrument and each of its subsystems was analyzed in a series of computer simulations. The initial design goal of an overall precision of better than 3%, for an air mass of ≤ 3 , required stringent design specifications. Several iterations of the process allowed us to find a set of specifications that both met the initial criteria and were realistically achievable.

The optical block is machined from a cast aluminum plate to assure long-term mechanical stability. The plate is suspended in the enclosure in such a way that a mechanical strain applied to the enclosure does not transmit directly to the optical block. The mechanical alignment of each of the five optical collimators bored through the block is better than 0.1° , and the Sun-targeting assembly is laser-aligned to within 0.1° of the optical axis of the block. Three internal black plastic baffles and low-reflectance linings in each collimator prevent internal reflec-

Table 1. UV Filter Specifications

	Filter 1	Filter 2	Filter 3
Center wavelength	300 ± 0.3 nm	305.5 ± 0.3 nm	312.5 ± 0.3 nm
FWHM	2.4 ± 0.4 nm	2.4 ± 0.4 nm	2.4 ± 0.4 nm
Angle of incidence	0	0	0
Maximum out-of-band transmission (relative to peak wavelength)			
λ < 650 nm	10 ⁻⁷	10 ⁻⁶	10 ⁻⁵
λ > 650 nm	10 ⁻⁵	10 ⁻⁴	10 ⁻⁴
Minimum peak transmission		15%	
Temperature coefficient of center wavelength		<0.005 nm/°C	
Wet/dry shift		<0.1 nm	
Long-term stability		<0.1 nm/yr	
Operating environment			
Temperature		-20° to +40°C	
Relative humidity		0–100%	

tions from reaching the photodetector. The baffled collimators provide a FWHM field of view of <2.5°.

The temperature of the optical block is monitored and logged during each scan in order to allow temperature compensation. A built-in solid-state pressure sensor provides the atmospheric pressure needed to calculate the Rayleigh scattering coefficient for the calculation of column ozone and the AOT at 1020 nm.

Special consideration was given to the optical filters and photodetectors, particularly for the UV channels (see Table 1). The most critical and difficult to meet specification was the requirement for high out-of-band rejection. The computer simulation called for out-of-band leakage no greater than 10⁻⁷ (λ < 650 nm) for the 300 nm channel. Lower wavelength filters have stricter leakage requirements, because the in-band signal is much weaker than that at higher wavelengths. The filters were manufactured by Barr Associates using an ion deposition process. A typical transmission curve for a UV filter is shown in Figure 2. The repeatability of the center wavelength and FWHM band pass within a batch of filters is approximately 0.1 nm.

Ultraviolet filters generally have high out-of-band transmis-

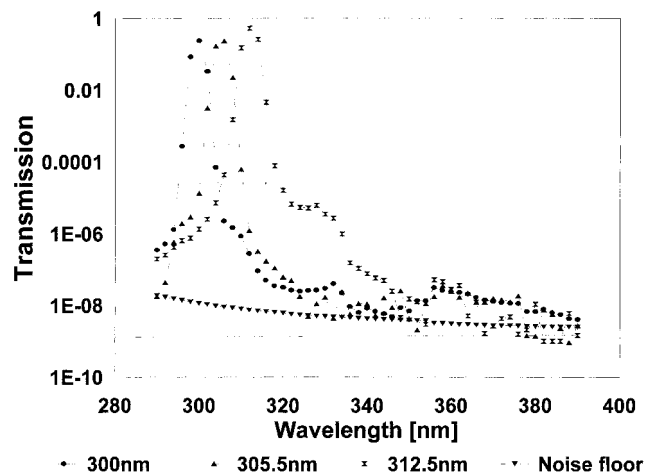

Figure 2. Spectral transmission of UV filters measured using a monochromator with 2.5 nm slit width (notice bandwidth broadening) in order to detect the stray light. Read 1E-06 as 1×10^{-6} .

sion in the near-infrared near the peak response of silicon photodiodes. For this reason, the same kind of gallium phosphide (GaP) photodiodes used in the original TOPS and Microtops are used for the three UV channels of MICROTUPS II. GaP photodiodes are characterized by relatively strong sensitivity in the UV, good noise properties, and low sensitivity above 500 nm. These characteristics allowed us to relax the out-of-band rejection above 650 nm, thus lowering the production cost of the filters. The photodetectors are hermetically packaged to assure long life and stability.

As discussed in section 3, conventional interference filters are subject to degradation over time because of solarization, moisture, and other factors. While many of the conventional interference filters used in the 30 original Microtops instruments began to degrade within several years of manufacture, the ion deposition UV filters used in MICROTUPS II have thus far proved to be quite stable. For example, column ozone retrieval comparisons with the station Dobson at Mauna Loa Observatory (instrument 76) and one of the first MICROTUPS II (instrument 4) have been conducted each spring since 1996. The original 1996 MICROTUPS II calibration algorithm has been used for this ongoing series of annual tests to determine if filter changes have occurred. Thus far these annual comparisons have consistently yielded a column ozone agreement on the order of 1%, which is similar to the agreement found during the 52 day comparison of Supertops with Brewer 112 in 1995.

It would be desirable to periodically remove and test the spectral response of the filters in a MICROTUPS II. However, this procedure is not without risk since removing and reinstalling filters may induce slight positional changes or dust that might alter the instrument's calibration. Nevertheless, we plan to conduct such a test, which will be preceded and followed by Langley calibration tests, and report on our findings in a future paper that also discusses in detail comparisons of MICROTUPS II (instrument 4) with the MLO station Dobson and other ozone instruments.

5.2. Signal Conditioning and Processing

On a clear day the solar radiation at short UV wavelengths decreases rapidly with increasing air mass because of absorption by ozone (Figure 3). Thus MICROTUPS II must be able to measure very weak and very strong signals with adequate signal-to-noise ratio and high linearity. Therefore the input

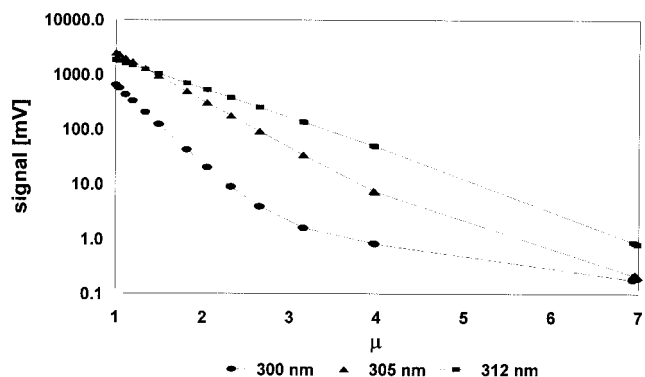

Figure 3. Signal measured by MICROTOPS II at Mauna Loa Observatory, Hawaii (May 16, 1996, 271 DU, clear sky).

amplification stage for each photodiode is optimized to have the lowest noise level. To reduce interference from power lines and other external sources of electrical noise, the bandwidth of the amplifiers is reduced to 10 Hz and kept equal for all channels. Careful layout and shielding of the circuit board keeps the amplifier output noise to a maximum of 5.8 μV RMS.

A high-performance sigma-delta analog-to-digital (A/D) converter with on-chip digital filtering converts the amplified photodetector signal into a 20 bit digital word. The conversion nonlinearity is less than 0.0015% over the entire input range, and the A/D conversion noise level is 5.3 μV RMS. The full-scale output of the A/D converter is 2.5 V. The A/D converter's filter is programmed to reject electromagnetic interference caused by electrical power lines, with the frequency being user selectable. When the user presses the scan button, the instrument stores the time and date for the solar zenith angle calculation and performs a user-programmable number of measurements of all five channels in rapid sequence. These measurements are processed numerically to further lower the noise level and improve targeting accuracy. Overall, the dynamic range achieved in the instrument is over 300,000, which leaves adequate signal-to-noise margins for very weak signals.

To assure long-term stability of measurements, the electronic circuitry has to be very stable, both thermally and over time. The gain of the amplifiers is determined by a set of precision resistors with temperature coefficients below 0.005% per degree Celsius. The amplifier's offset is automatically compensated each time the instrument is powered on. Both the offset and full scale of the A/D converter are automatically calibrated before each scan. The full-scale calibration relies on a high-performance voltage reference with a temperature coefficient $\leq 0.001\%$ per degree Celsius and long-term stability of 0.005% per year. Careful design of the signal-conditioning-and-processing block reduces the effect of any electrical instability to a negligible level, thus simplifying characterization and calibration of the instrument.

5.3. Sun Targeting

MICROTOPS II must be pointed directly at the Sun during use. A Sun target on the front panel of the instrument facilitates aiming. When the instrument is pointed in the general direction of the Sun, a bright point of light appears in the Sun target. The instrument's position is then adjusted until the point of light falls at the intersection of a cross hair in the Sun

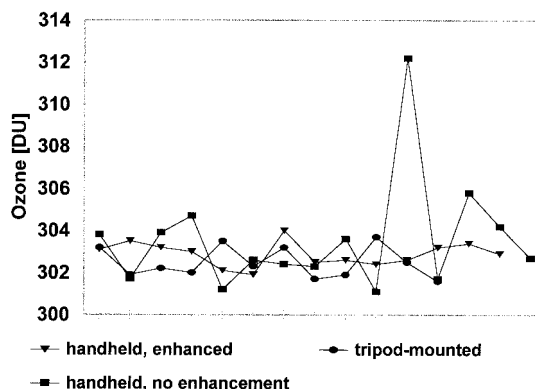

Figure 4. Series of consecutive MICROTOPS II measurements of ozone employing three different Sun-targeting methods.

target window. The scan button is then pressed manually, or a scan is initiated by an external computer.

While optionally equipped with hardware for tripod mounting, the MICROTOPS II is designed primarily for handheld operation. There is a concern about the accuracy of pointing the meter toward the Sun. A series of tests indicated that even in the hands of a well-trained operator, the instrument can move up to 1° away from the Sun's center. Presence of strong wind or cold weather may further degrade the steadiness of the operator's hand. Handheld stability is much better when the operator is seated and the elbows are rested against the legs or, especially, when the instrument is rested against a table or other rigid surface.

To enhance the Sun-targeting accuracy in the MICROTOPS II, an algorithm was implemented that analyzes a series of rapidly repeated measurements. A signal strength factor is calculated based on the signal from all three UV channels. Only the records with highest-ranking signal strength factor are averaged and passed for further processing. The user can set the total number of measurements in a scan as well as the number of records averaged.

Figure 4 presents the results of three consecutive series of 32 rapid (10 s total) ozone measurements performed on a fairly clear day with the same instrument. Each of the measurement series employs a different Sun-targeting technique. The first series, which is handheld, employs the targeting enhancement algorithm. The result of the second series, which is also handheld, is the average of all 32 measurements. The result of the third series, which was measured with the MICROTOPS II mounted on a tripod, is also the average of all 32 measurements. Table 2, which shows the standard deviation of each measurement series, reveals that the handheld series with targeting enhancement offers the most repeatable results (standard deviation of 0.18%). The targeting enhancement produces results slightly better than those with the tripod-

Table 2. Performance of Sun-Targeting Methods

Targeting Method	Standard Deviation
Handheld, no enhancement	0.87%
Handheld, enhanced	0.18%
Tripod mounted	0.23%

mounted instrument by compensating the targeting error due to limited resolution of the instrument's targeting system.

6. Calibration and Measurement of Column Ozone

Calibration of the MICROTOPS II instrument requires that the intensity of radiation measured at each channel be analyzed assuming the validity of the Lambert-Beer law, which when applied to ozone absorption and Rayleigh scattering by the atmosphere is

$$I = I_o e^{-\alpha\mu\Omega - m\beta P/P_o}, \quad (1)$$

where I_o is the intensity of the light of a particular wavelength before it passes through the atmosphere, I is the intensity remaining after all processes attenuating the incident radiation have occurred, Ω is the amount of ozone, α is the ozone absorption coefficient at the specific wavelength, μ is the ratio of the actual and vertical path lengths of the radiation through the ozone layer, P is the pressure of the atmosphere in millibars, P_o is standard pressure (1013.25 mbars), and m is the relative air mass, which is defined as the ratio of the actual and vertical path lengths of the radiation through the entire atmosphere to the detector. For $m < 2$, μ and m are very close. Other processes determining the radiation transfer include molecular scattering by the atmosphere (the Rayleigh scattering coefficient β) and scattering caused by aerosols.

It is customary to ignore the aerosol scattering when ozone is computed from two pairs of wavelengths. For example, moderate haze does not generally affect ozone measurements by more than a few percent and much less under usual conditions [Basher and Thomas, 1979]. The negative effect of aerosol scattering is enhanced when only one pair of wavelengths is used, as in MICROTOPS II and its predecessors. However, using very closely spaced wavelengths that minimize the difference in the absorption coefficients at the two wavelengths reduces the aerosol effect on these instruments. In practice, MICROTOPS II ozone observations are more consistent and agree better with Dobson and Brewer ozone measurements when the sky is free of haze. An important advantage of MICROTOPS II when many clouds are present is that an ozone measurement can be made during a few seconds when the Sun is open. Since a Brewer must perform a mechanical scan of wavelengths, it requires more time to conduct an ozone measurement and may not function as well when clouds are frequently blocking the Sun.

Expressions for μ and m are [Kohmyr, 1980; Kohmyr et al., 1989]

$$m = \sec Z - 0.0018167(\sec Z - 1) - 0.002875(\sec Z - 1)^2 - 0.0008083(\sec Z - 1)^3, \quad (2)$$

$$\mu = \frac{R + h}{[(R + h)^2 - (R + r)^2 \sin^2 Z]^{1/2}}, \quad (3)$$

or, more conveniently,

$$\mu = \frac{1}{\sqrt{1 - v \sin^2 Z}}, \quad (4)$$

where v is a geometric factor for the height of the ozone layer given by

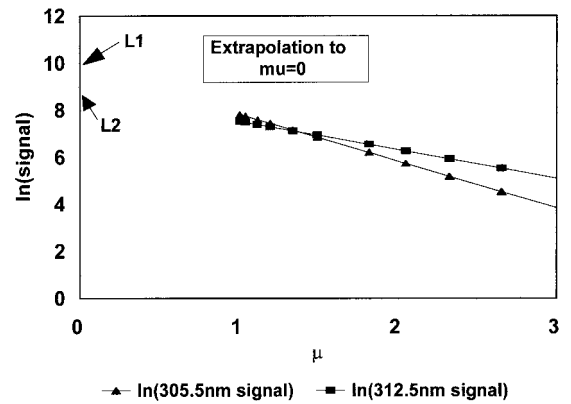

Figure 5. Illustration of the MICROTOPS II calibration procedure.

$$v = \frac{(R + r)^2}{(R + h)^2}, \quad (5a)$$

where R is the mean Earth radius (6371 km), r is the height of the instrument above sea level in kilometers, and h is the height of the ozone layer above sea level, which is approximated as

$$h \text{ (km)} = 26 - 0.1 \text{ LATITUDE (deg)}. \quad (5b)$$

As noted by an anonymous reviewer of this paper, at high solar zenith angles an error of a few kilometers in the height of the ozone layer can cause a small error in the ozone retrieval. The air mass limitation of MICROTOPS II largely precludes this error.

The calculation of the solar zenith angle Z (SZA, angle of Sun with respect to the zenith), which is the basis for the calculation of μ and m , is based on the coordinates of the measurement site and universal time (UT). The algorithm implemented in MICROTOPS II was tested to an accuracy of $\pm 0.03^\circ$ (maximum error) for the entire practical range of latitudes and longitudes for the time period of 1996–2006. Accurate astronomical algorithms [Meus, 1991] executed in double precision were used as a reference. The error arises partially from simplified algorithms and partially from the use of single-precision arithmetic on board MICROTOPS II. This error causes negligible effect on ozone calculations. MICROTOPS II is equipped with a real-time clock and calendar. The coordinates of the location are entered from the keypad, an external computer, or a GPS receiver.

The theoretical expression for the ozone value derived for any channel pair (indexed by 1 and 2 in this paper) is as follows:

$$\Omega = \frac{1000 \left[L_{1-2} - \ln \left(\frac{I_1}{I_2} \right) - \beta_{1-2} m \frac{P}{P_o} \right]}{\alpha_{1-2} \mu} \text{ DU}, \quad (6)$$

where α_{1-2} is $(\alpha_1 - \alpha_2)$, the difference in the ozone coefficients for respective channels 1 and 2; β_{1-2} is $(\beta_1 - \beta_2)$, the difference in the air scattering coefficients for respective channels 1 and 2; and $L_{1-2} = (L_1 - L_2) = \ln(I_{o1}/I_{o2})$, the combined extraterrestrial constant (Figure 5). L_{1-2} corresponds to the incident radiation above the Earth's atmosphere (no attenuation from absorption or scattering). It is obtained by the Langley method, which has a long history of application

to Dobson instruments [Dobson and Normand, 1962] and Sun photometers. Measurements are taken over a range of air masses on a clear day. Both research and commercial versions of the instrument are calibrated in this fashion at Mauna Loa Observatory. A regression analysis of $\ln(I_1/I_2)$ versus μ is performed on the most linear portion of the Langley plot for each channel, and the data are appropriately weighted. The intercept gives the extraterrestrial constant for that channel. The ozone column thickness is expressed in Dobson units, which correspond to matm cm .

The α and β for each channel were calculated using a model developed by the TERC project [Bannasch et al., 1994]. The substitutions $a = -\alpha\Omega$ and $b = -\beta P/P_o$ are implemented to linearize the exponential equation (1), and a new weighted air mass ω is defined as

$$\omega = \frac{a\mu + bm}{a + b}. \quad (7a)$$

From (1) and (7a),

$$\ln I = \ln I_o + (a + b)\omega. \quad (7b)$$

Equation (7b) is a linear function of ω and does not rely on the assumption $m \sim \mu\delta$, which is only true for a limited range of SZA. This linearization method is particularly useful when good-quality observations cannot be obtained at a low air mass. Equation (7b) yields a value for $\ln(I_o)$ and the $(\alpha + \beta)$ slope value when subjected to regression analysis. That constant must then be broken down into a term for ozone absorption and a term for the Rayleigh scattering. TERC developed a simple model which assumes that a narrow-band-pass filter acts like a filter of a single wavelength. This forces an additional constraint on the coefficients to be determined, because they must both be appropriate for that wavelength. Very helpful is the fact that the α and β change differently with wavelength. To simplify the determination of α and β , the wavelength dependencies of these coefficients were calculated with the following two equations, derived by fitting the ozone cross sections derived by Molina and Molina [1986] and the Rayleigh coefficients of Penndorf [1957]:

$$\alpha(\lambda) = (2.1349 \times 10^{19})e^{(-0.14052\lambda)}, \quad (8)$$

$$\beta(\lambda) = (16.407 - 0.085284\lambda + 0.00011522\lambda^2), \quad (9)$$

where λ is the wavelength in nanometers.

Substituting (8) and (9) into (7b), one can calculate the slope Δ of the $\ln(I)$ versus ω line using

$$\Delta = -1\alpha(\lambda)\Omega/1000 + \beta(\lambda)P/P_o. \quad (10)$$

The effective wavelength λ_o of each channel's interference filter is determined by finding the wavelength at which the slope of the natural logarithm of the measured signal (Figure 5) matches the theoretical slope Δ . The ozone column for the calculation of Δ is taken from a colocated independent instrument, such as a Dobson spectrophotometer. An onboard pressure sensor measures the barometric pressure. Once λ_o is known, α and β for each channel can be calculated from (8) and (9). Since the new weighted air mass ω is weakly dependent on α and β , this fitting process must be iterated several times to reach equilibrium. For the filters used in Microtops II the effective wavelengths are fraction of a nanometer above the filter's center wavelength (Table 3).

Table 3. Effective Wavelength Versus Filter Center Wavelength

MICROTOPS II Filter Center Wavelength, nm	Typical Effective Wavelength, nm
300.0	300.8
305.5	306.0
312.5	312.6

7. Column Ozone Results

Numerous field tests indicate that a properly calibrated MICROTOPS II gives reproducible results over a wide range of altitudes and under various weather and climatic conditions. Figure 6 shows the results of a comparison between a Dobson spectrophotometer and a MICROTOPS II instrument in Boulder, Colorado, during a demonstration of a Dobson instrument operated by the National Oceanic and Atmospheric Administration (NOAA) Climate Monitoring and Diagnostics Laboratory. The MICROTOPS II instrument was previously calibrated at the Mauna Loa Observatory under substantially different climatic and altitude conditions. The typical agreement between multiple MICROTOPS II instruments is within 1–2%. The repeatability of consecutive ozone measurements is better than 0.5% (Figure 4). Measurements through broken clouds or in very hazy conditions show a variability of 1–2%.

Independent comparisons of MICROTOPS II with other instruments are underway, and early results indicate good agreement. Thus far the most detailed independent comparison is by Köhler [1999], who has compared MICROTOPS 3128 with Dobson 104 and Brewer 65 for some 2 years at Hohenpeissenberg, Germany. He has also conducted comparisons with Dobson 64 and World secondary standard Dobson 65. Köhler [1999, p. 1385] concludes, “The differences between the various instruments are mostly less than $\pm 2\%$, increasing at air masses higher than 3.5 or at hazy sky conditions.” As noted in section 5, the UV filters in MICROTOPS II are manufactured using an ion deposition process. In view of the serious degradation problems associated with conventional interference filters, it is especially notable that Köhler [1999, p. 1385] found that “adverse effects of the filter aging or a calibration drift could not be detected over this 21-months period.”

As with other spectrophotometers [Degorska and Rajewska-Wiech, 1993], MICROTOPS II exhibits some air mass dependency [Köhler, 1999]. This effect is probably caused by out-of-

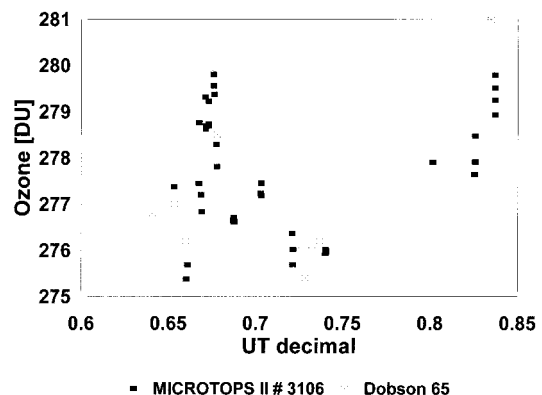

Figure 6. Comparison of MICROTOPS II 3106 with Dobson 65 at Boulder, Colorado (August 1, 1996).

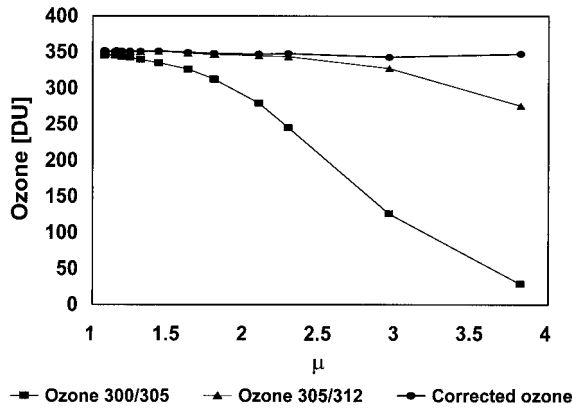

Figure 7. Measurement of ozone over a wide range of air masses at Philadelphia, Pennsylvania (May 31, 1006).

band radiation leaks and scattering of diffuse UV radiation into the instrument's field of view. Figure 7 shows a series of measurements performed during a sunny day in Philadelphia, Pennsylvania, over a wide range of μ . The ozone calculations based on a single pair of wavelengths, such as 300–305 nm or 305–312 nm, show the air mass dependence effect. An empirical formula for correcting this effect is

$$\Omega_{\text{corr}} = \Omega_{305-312} \left[1 + \left(\frac{\Omega_{305-312}}{\Omega_{300-305}} - 1 \right) \text{OC} \right], \quad (11)$$

where OC is a parameter determined by a best fit of a series of Ω_{corr} values to the accepted ozone value. The application of (11) substantially extends the instrument's measuring ability at high air masses. One of us (S. Anderson) has found that it is possible to use an alternative polynomial fitting procedure for each wavelength combination to extend the air mass range and also correct for this dependency.

The quality of calibration depends strongly on the clarity of the atmosphere when the Langley method is used, limiting the number of locations where the calibration can be performed. A calibration based on the spectroradiometric measurements of individual filters is proposed [Labow *et al.*, 1996; Flynn *et al.*, 1996]. While it might prove convenient for the initial calibration, the subsequent recalibrations would be difficult to conduct since the instrument would have to be disassembled in order to measure the spectral responses of the filters.

Thus far all commercial MICROTOPS II instruments have been calibrated using the Langley method at Mauna Loa Observatory. Since 1992, F. M. Mims has conducted annual Langley calibrations at MLO using various MICROTOPS II instruments and its predecessors. All these tests have been conducted within a few tens of meters from MLO station Dobson (instrument 76). Present during some of these tests were the World Standard Dobson (instrument 83) and two Brewers from Canada's Atmospheric Environment Service (AES). Agreement between MICROTOPS II 4 and Dobson 76 and 83 is typically better than 1%. These results are very similar to those obtained during the 1995 comparison of Brewer 112 and Supertops. A future collaborative paper will describe in detail the field calibration procedures and results of simultaneous ozone measurements by MICROTOPS II 4 and these instruments. This paper will also report more on the air mass dependency of the instrument, the long-term (>5 years) stability of its ion-deposited UV filters, and the results of an

ongoing, long-term (1990 to present) comparison with ozone retrievals from the TOMS instrument aboard various NASA satellites.

8. Measurement of Column Water Vapor

Solar UV passing through the atmosphere can be modulated as much by haze in the troposphere as by ozone in the stratosphere. Since the optical thickness of haze is often related to the column amount of water vapor, two of the five channels in Microtops and MICROTOPS II have been traditionally devoted to the measurement of column water vapor. This measurement also provides the optical thickness at 1020 nm, which is at an atmospheric window free of gaseous absorption.

The attenuation of sunlight caused by water vapor has been studied for almost a century. The calibration technique used for Microtops was developed by Reagan *et al.* [1987] and further tested by Michalsky *et al.* [1995]. The water vapor measurement is based on a pair of radiometric measurements in the near-infrared. The 940 nm filter (10 nm, FWHM) is located in a strong water vapor absorption band, while the 1020 nm filter (10 nm, FWHM) is affected only by aerosol scattering.

For the 940 nm channel (indexed with 1) located in the water vapor absorption band the Bouguer-Lambert-Beer law takes the form

$$V_1/V_{01} = \exp[-\tau_{a1}m - k(um)^b], \quad (12)$$

where V_1 is the ground-based irradiance at 940 nm, V_{01} is the extraterrestrial radiation, τ_{a1} is the aerosol scattering coefficient at 940 nm, u is the vertical water vapor column thickness, m is the air mass, and k and b are constants numerically derived for the filter. For clarity the Sun-Earth distance correction is omitted in the formulas given here. However the instrument automatically applies this factor during calculations, and the extraterrestrial constants are referenced to the mean Sun-Earth distance.

For the 1020 nm channel there is negligible water vapor absorption, and the equation takes the form

$$\frac{V_2}{V_{02}} = \exp(-\tau_{a2}m). \quad (13)$$

A radiation transfer model was used to calculate the spectral irradiance around 940 nm for the standard U.S. atmosphere and various air masses. Subsequently, the spectral irradiances from the model were multiplied by the 940 nm filter's transmission curve to produce the theoretical signal from the 940 nm detector. On the basis of (12) a set of k and b parameters was found that matches most closely the simulated results.

The V_{01} for the instrument is found from an extrapolation to air mass zero of the linearized (12):

$$\ln(V_1) + \tau_{a1}m = \ln(V_{01}) - k(um)^b. \quad (14)$$

Since k and b are already known, $\ln(V_{01})$ is the intercept from the linear regression of (14) versus m^b .

For the water vapor calculation the aerosol scattering coefficients at 940 and 1020 nm (τ_{a1} and τ_{a2}) are needed. The aerosol scattering coefficient τ_{a2} at 1020 nm is first measured on the basis of (13). The V_{02} is obtained from extrapolation of a Langley plot on a clear day. From the radiation transfer model a relationship between τ_{a1} and τ_{a2} is found for a standard atmosphere, and because of a close proximity of the two

bands it is assumed constant for other conditions. For the filters used in MICROTUPS II the relationship is

$$\tau_{a1} = 1.16\tau_{a2}. \quad (15)$$

The vertical water vapor column is calculated as

$$u = \left(\frac{\ln(V_{01}) - \ln(V_1) - 1.16\tau_{a2}m}{km^b} \right)^{1/b}. \quad (16)$$

9. Column Water Vapor Results

Column water vapor is measured each time MICROTUPS II measures column ozone. As the emphasis with MICROTUPS II and its predecessors has been the measurement of total ozone, the column water vapor measurements by MICROTUPS II have yet to be fully analyzed. Here we report preliminary results from daily observations at solar noon at Geronimo Creek Observatory.

Column water vapor has been regularly measured at Geronimo Creek Observatory since February 4, 1990, using a novel near-infrared hygrometer developed by Mims [1992b]. This instrument uses a pair of near-infrared light-emitting diodes (LEDs) as spectrally selective photodiodes. Annual Langley calibrations conducted at Mauna Loa Observatory since 1992 have demonstrated that this and similar LED Sun photometers are far more stable than instruments that use conventional interference filters [Mims, 1999]. The measured drift of the extraterrestrial constant derived from such instruments is $\sim 1\%$ per decade.

Various preliminary comparisons of column water vapor measured by the original LED near-IR hygrometer and by MICROTUPS II at Geronimo Creek Observatory have been conducted [Limaye et al., 2000]. The peak column water vapor at this site occurs in August. During August 1999 the mean column water vapor measured by the LED instrument and MICROTUPS II was 4.49 cm and 4.41 cm, respectively. Thus the MICROTUPS II mean is only 1.8% below that of the LED instrument. During the drought conditions of August 2000 the mean column water vapor measured by the LED instrument and MICROTUPS II was 3.59 cm and 4.44 cm, respectively. Here the difference is far greater than during 1999, with the MICROTUPS II mean being 23.7% higher than that of the LED instrument.

The significance of this preliminary comparison is twofold. First, from mid-1997 to late 1999 there is excellent agreement between the dew point calibration of the LED instrument [Mims, 1992b] and the model calibration of MICROTUPS II described herein. Thereafter, however, there is an obvious upward trend in the MICROTUPS II results. This increase is to be expected if the transmissivity of one or both of the conventional near-IR filters in this particular MICROTUPS II has drifted upward, thus altering the validity of the model calibration. As noted in section 7 the ion-deposited UV filters used for the column ozone retrievals with the same MICROTUPS II have to date exhibited no noticeable drift. The drift problem with the near-IR channels can be resolved by the use of ion-deposited filters or by substituting appropriate near-IR LEDs for the 940 nm and 1020 nm channels in MICROTUPS. F. M. Mims modified a MICROTUPS II in this manner in 1999 and will report on the results in a forthcoming paper. Results of an ongoing comparison of water vapor retrievals from GOES and MICROTUPS II [Limaye et al., 2000] will also be reported.

10. Conclusion

MICROTUPS II is a low-cost, handheld instrument that provides quick and accurate measurements of total ozone, water vapor, and aerosol optical thickness. The instrument, which can be operated manually or under computer control, stores in nonvolatile memory up to 800 measurement scans. The filter degradation problems that have adversely affected previous filter ozonometers have been largely overcome by the use of ion-deposited interference filters. Tests indicate that the instrument gives reproducible results over a wide range of altitudes and under various weather and climatic conditions. Comparisons by F. M. Mims of well-calibrated MICROTUPS II instruments with Dobson and Brewer instruments at Mauna Loa Observatory and elsewhere yield agreement on the order of $<1\%$ when the air mass is <2.5 . A 2 year comparison of MICROTUPS II 3128 with Dobson 104 and Brewer 110 yielded agreement to within 2% when the air mass was <3.5 [Köhler, 1999].

Both ozone and Sun photometer versions of MICROTUPS II are now in use at many locations around the world [see, e.g., Köhler, 1999; Meywerk and Ramanathan, 1999; Satheesh and Ramanathan, 2000]. While the instrument is not designed to replace a Dobson or Brewer, it is considerably smaller, much less expensive, and generally as accurate as a Dobson or Brewer within its usable air mass range. Therefore we suggest that MICROTUPS II has the potential for becoming a useful tool for measuring column ozone, column water vapor, and aerosol optical thickness for climatological purposes and special research studies at a wide range of locations. We emphasize, however, that the instrument is only as good as its calibration. Therefore periodic recalibrations of the instrument on at least an annual basis should be conducted, either by the Langley method on very clear days or by comparison with other instruments with a known calibration history. Between such calibrations the instrument's daily performance can be checked by comparisons with satellite ozone measurements by, for example, NASA's EarthProbe TOMS.

Acknowledgments. Many have assisted in various ways in the development of MICROTUPS II. We especially wish to thank Robert Evans and Mark Clark of NOAA/ERL/CMDL, Russel Schnell of the Mauna Loa Observatory, and Francis Schmidlin and Larry Rossi of the Wallops Island Observatory for their help in evaluating and calibrating various MICROTUPS II instruments as well as their valuable comments. We also thank William Barnard of the EPA and John E. Rives of the University of Georgia for placing Brewer 112 at the Geronimo Creek Observatory in 1995. We are particularly grateful to Daniel Berger and Saul Berger of the Solar Light Company for financing the development and production of MICROTUPS II. Finally, we thank two anonymous reviewers for their many thoughtful suggestions that have enabled us to significantly improve the paper.

References

- Bannasch, S., G. Unger, and P. Wagoner, Preliminary calibration of TERC Total Ozone Spectrometer, TERC, Cambridge, Mass., 1994.
- Basher, R. E., Stratospheric circulation: A narrowband spectrophotometer for total ozone determination, Univ. of Canterbury, Christchurch, N. Z., 1975.
- Basher, R. E., The effect of bandwidth on filter instrument total ozone accuracy, *J. Appl. Meteorol.*, 16, 803–811, 1977.
- Basher, R. E., and W. A. Matthews, Problems in the use of interference filters for spectrophotometric determination of total ozone, *J. Appl. Meteorol.*, 16, 795–802, 1977.
- Basher, R. E., and R. W. L. Thomas, Atmospheric aerosol effect on

- Dobson total ozone measurements: A simple approach, *Appl. Opt.*, **18**, 3361–3362, 1979.
- Bojkov, R. D., Differences in Dobson spectrophotometers and filter ozonometer measurements of total ozone, *J. Appl. Meteorol.*, **8**, 362–368, 1969.
- Boleshakova, L. G., A. L. Osherovich, and I. V. Peisakhson, *Atmospheric Ozone in Ozone Symposium*, Moscow Univ. Press, Moscow, 1961.
- Degorska, M., and B. Rajewska-Wiech, Airmass-dependent total ozone measurement errors, *Publ. Inst. Geophys. Pol. Acad. Sci. D*, **D-40**, 263, 1993.
- Dobson, G. M. B., and C. W. B. Normand, Determination of constants used in the calculation of the amount of ozone from spectrophotometer measurements and an analysis of the accuracy of the results, *Ann. Inst. Geophys. Year*, **5**, 161–191, 1962.
- Flynn, L. E., G. L. Labow, R. A. Beach, and M. A. Rawlins, Estimation of ozone with total ozone portable spectroradiometer instruments, I, Theoretical model and error analysis, *Appl. Opt.*, **35**, 6076–6083, 1996.
- Gushchin, G. P., Universal ozonometer, *Proc. Main Geophys. Obs. Leningrad*, **141**, 83–98, 1963.
- Khrgian, A. K., *The Physics of Atmospheric Ozone* (in Russian), Gidrometeoizda, Saint Petersburg, 1973. (English translation, Isr. Program for Sci. Transl., Jerusalem, 1975.)
- Köhler, U., A comparison of the new filter ozonometer MICROTOPS II with Dobson and Brewer spectrometers at Hohenpeissenberg, *Geophys. Res. Lett.*, **26**, 1385–1388, 1999.
- Kohmyr, D., Operations handbook: Ozone observations with a Dobson spectrometer, World Meteorol. Organ., Geneva, 1980.
- Kohmyr, D., R. D. Grass, and R. K. Leonard, Dobson Spectrophotometer 83: A standard for total ozone measurement, 1962–1987, *J. Geophys. Res.*, **94**, 9847–9861, 1989.
- Labow, G. J., L. E. Flynn, M. A. Rawlins, R. A. Beach, C. A. Simmons, and C. M. Schubert, Estimation of ozone with total ozone portable spectroradiometer instruments, II, Practical operation and comparisons, *Appl. Opt.*, **35**, 6084–6089, 1996.
- Limaye, S. S., R. A. Pertzborn, A. S. Levine, G. Bowen, F. M. Mims III, and D. Butler, Education and public outreach program for GIFTS, the EO-3 New Millennium Mission, paper presented at International Geoscience and Remote Sensing Symposium (IGARSS 2000), Int. Geosci. and Remote Sens. Soc., Honolulu, Hawaii, July 24–28, 2000.
- Matthews, W. A., Atmospheric ozone, Univ. of Canterbury, Christchurch, N. Z., 1971.
- Matthews, W. A., R. E. Basher, and G. J. Fraser, Filter ozone spectrophotometer, *Pure Appl. Geophys.*, **112**, 931–938, 1974.
- Meeus, J., *Astronomical Algorithms*, Willmann-Bell, Richmond, Va., 1991.
- Meywerk, J., and V. Ramanathan, Observations of the spectral clear-sky aerosol forcing over the tropical Pacific Ocean, *J. Geophys. Res.*, **104**, 24,359–24,370, 1999.
- Michalsky, J. J., J. C. Liljegren, and L. C. Harrison, A comparison of Sun photometer derivations of total column water vapor and ozone to standard measures of the same at the Southern Great Plains Atmospheric Radiation Measurement site, *J. Geophys. Res.*, **100**, 25,995–26,003, 1995.
- Mims, F. M., III, How to measure the ozone layer, *Sci. Probe*, **2**, 45–51, 1992a.
- Mims, F. M., III, Sun photometer with light-emitting diodes as spectrally selective detectors, *Appl. Opt.*, **31**, 6965–6967, 1992b.
- Mims, F. M., III, Satellite monitoring error, *Nature*, **361**, 505, 1993.
- Mims, F. M., III, An international haze-monitoring network for students, *Bull. Am. Meteorol. Soc.*, **80**, 1421–1431, 1999.
- Mims, F. M., III, and E. R. Mims, Fluctuations in column ozone during the total solar eclipse of July 11, 1991, *Geophys. Res. Lett.*, **20**, 367–370, 1993.
- Mims, F. M., III, J. Ladd, and R. Blaha, Increased solar ultraviolet-B associated with record low ozone over Texas, *Geophys. Res. Lett.*, **22**, 227–230, 1995a.
- Mims, F. M., III, F. Barnard, A. C. Neuendorffer, and G. J. Labow, Unusually low ozone detected over south-central U.S., *Eos Trans. AGU*, **76**(11), 113–115, 1995b.
- Molina, L. T., and M. J. Molina, Absolute absorption cross sections of ozone in the 185- to 350-nm wavelength range, *J. Geophys. Res.*, **91**, 14,501–14,508, 1986.
- Osherovich, A. L., M. Y. M. Y. Rozinskiy, and S. A. Furman, A comparison between the M-83 standard ozonometer and an ozonometer equipped with narrowband interference filters, *Izv. Russ. Acad. Sci. Atmos. Oceanic Phys.*, **5**, 593–596, 1969.
- Penndorf, R., Tables of the refractive index for standard air and the Rayleigh scattering coefficient for the spectral region between 0.2 and 20 μm and their application to atmospheric optics, *J. Opt. Soc. Am.*, **47**, 176–182, 1957.
- Reagan, J., et al., Water vapor measurements in the 0.94 micron absorption band: Calibration, measurements and data applications, paper presented at International Geoscience and Remote Sensing Symposium, Int. Geosci. and Remote Sens. Soc., Ann Arbor, Mich., 1987.
- Reed, D. R., *Spirit of Enterprise: The 1993 Rolex Awards*, pp. 390–393, Buri Druck AG, Bern, 1993.
- Satheesh, S. K., and V. Ramanathan, Large differences in tropical aerosol forcing at the top of the atmosphere and Earth's surface, *Nature*, **405**, 60–63, 2000.
- Steblova, R. S., Notes on International Symposium on Atmospheric Ozone and Certification of Ozonometric Instruments (25 June–9 July 1974, Bielsk, Poland), *Izv. Russ. Acad. Sci. Atmos. Oceanic Phys.*, **11**, 128–129, 1975.
- S. E. Anderson, A. Baker, J. Kia, and T. Walkup, Westmont College, 955 La Paz Road, Santa Barbara, CA 93108. (anderso@westmont.edu)
- S. Hagerup and F. M. Mims III, Geronimo Creek Observatory, 433 Twin Oak Road, Seguin, TX 78155. (forrest.mims@ieee.org)
- M. Morys, Numar, a division of Halliburton, 508 Lapp Road, Malvern, PA 19355. (mmorys@erols.com)

(Received July 18, 2000; revised January 24, 2001; accepted January 25, 2001.)